

JRC GPS Module

Hardware Specification

This document specifies the electrical, mechanical, and behavioral characteristics of JRC GPS engine module.

Module: G591

Version: V2.0

Date: 2008-05-26



Japan Radio Co., Ltd.

Drawn	Checked	Released

Revision History			
Revision	Release date	Issuer	Change description
G591 V2.0	2008-5-20		Creative

CONFIDENTIAL

Contents

1 Description	1
2 Mechanical specifications	2
3 Electrical Specifications	3
4 Typical characteristics	4
5 Pin Definition.....	5
6 Reference PCB layout	7
7 Reference Design	7
8 NMEA output Sentence	9
9 Supplier's Responsibility	12
10 Notice for handling	12
11 ESD handling precautions	14

CONFIDENTIAL

1 Description

This document specifies the electrical, mechanical and behavioral characteristics of JRC GPS Module — G591.

The G591 is a GPS receiver module which providing the best solution with the highest sensitivity and tracking performance in the world and also with the highest position and speed accuracy in urban conditions.

The G591 GPS module uses the GPS solution with chipsets designed by JRC. Inc.

The G591 GPS module can supports up to 210 PRN channels, with 66 search channels and 22 simultaneous tracking channels. It supports signal procession of L1 band signals such as GPS C/A and SBAS(including WAAS,EGNOS MSAS).With the flexible software API and library ,customer can realize both autonomous navigation solution and assisted GPS navigation solution to obtain fast TTFF and accurate navigation performance even in harsh urban canyon or weak indoor signal environment.

The G591 GPS module is the best choice for you to design for GPS related products.

As following diagram is the G591 GPS Module architecture.

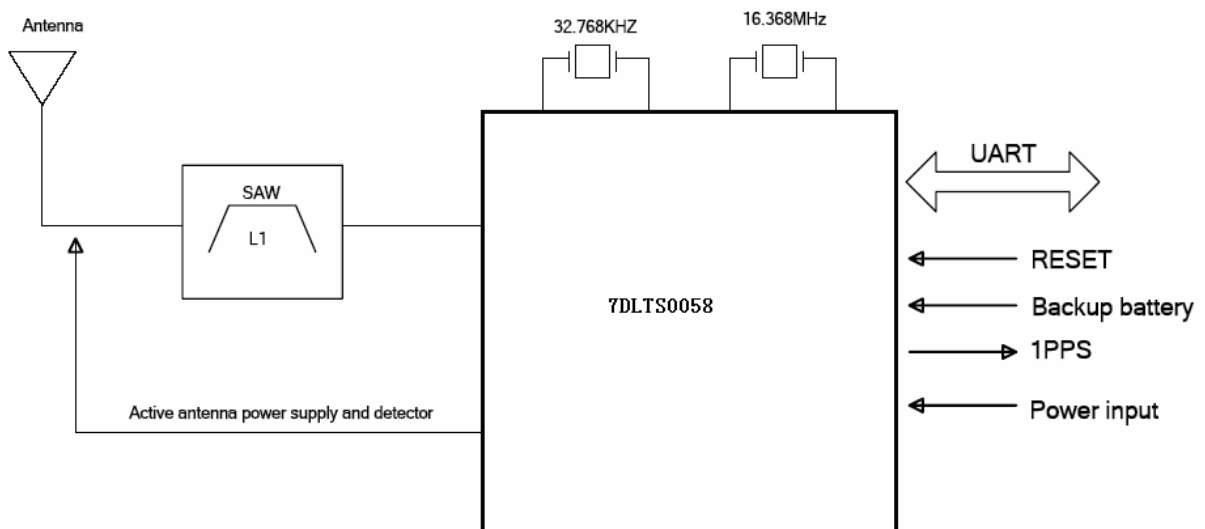

Figure 1 Module architecture

2 Mechanical specifications

The G591 GPS module has 36 pins on PCB board. A shield case is made of metallic material for suppressive RF radiation.

Figure 2 is the 3D diagram of it .

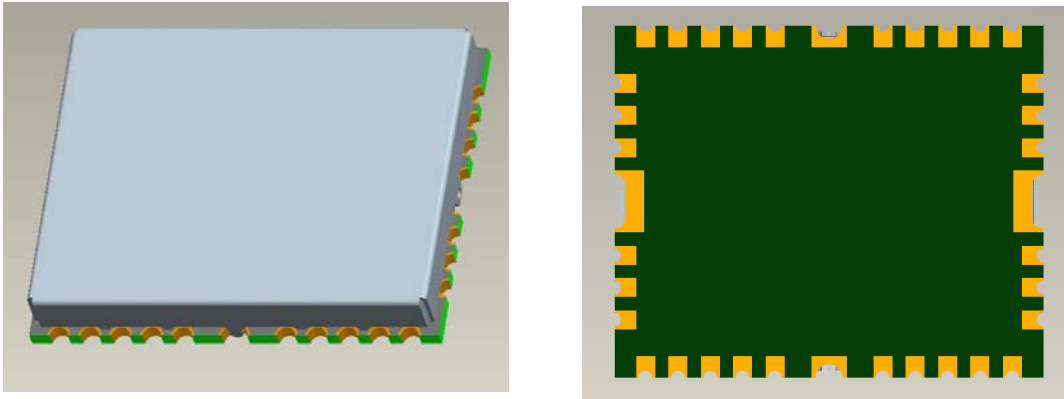

Figure 2

Table 1 is the mechanical dimensions and temperature character.

Item	Description
Width	13.1mm
Length	15.9 mm
Height	2.5 mm
Weight	1.03 g

Table 1



Please refer to the Mechanical Dimensions for the details.

3 Electrical Specifications

3.1 Absolute maximum ratings

Item	Symbol	Min	Max	Unit
Power supply voltage	Vcc_in	-0.3	4.2	V
Backup power input	VBU	-0.3	4.3	V
High level input voltage GPIO and data bus	VIH	2.0	3.6	V
low level input voltage GPIO and data bus	VIL	-0.3	0.8	V
Operating temperature	Topr	-40	85	°C
Storage temperature	Tstg	-40	125	°C

3.2 Recommended Input Voltage

Item	Symbol	Min	Type	Max	Unit
Power On	Vcc_in	2.7	3.3	4.2	V
Power Off	Vcc_in		0	0.1	V



The reasonable power supply ripple would be under 50mVpp

3.3 Recommended backup power input

Item	Symbol	Min	Type	Max	Unit
Backup power	VBU	2	3	4.3	V

3.4 Power consumption

State	Min	Type	Max	Unit
acquisition	—	50	—	mW
Tracking	—	38	—	mW

4 Typical characteristics

4.1 General information

Receiving Frequency	1575.42MHZ, C/A code
Channel	supports up to 210 PRN channels, with 66 search channels and 22 simultaneous tracking channels
Datum	WGS-84
Data output baud rate	9600bps(TXD,RXD)
Data Output Format	NMEA0183 V3.01

4.2 Sensitivity

acquisition	-148dBm
Re-acquisition	-157dBm
Tracking	-164dBm

4.3 Position&velocity &acceleration accuracy

Position accuracy	Without Aid: 3.0m (2D-RMS)
	DGPS: 2.5m
Velocity accuracy	Without Aid: 0.1m/s
	DGPS: 0.05m/s
acceleration accuracy	Without Aid: 0.1m/s ²
	DGPS: 0.05m/s ²

4.4 Dynamic performance

Maximum altitude	18000 m
Maximum velocity	515 m/s
Maximum acceleration	4 G

4.5 Time To First Fix

Hot start	< 1.5 s
Warm start	< 34 s
Cold start	< 35 s (autonomous)
Re-acquisition time	< 1 s

5 Pin Definition

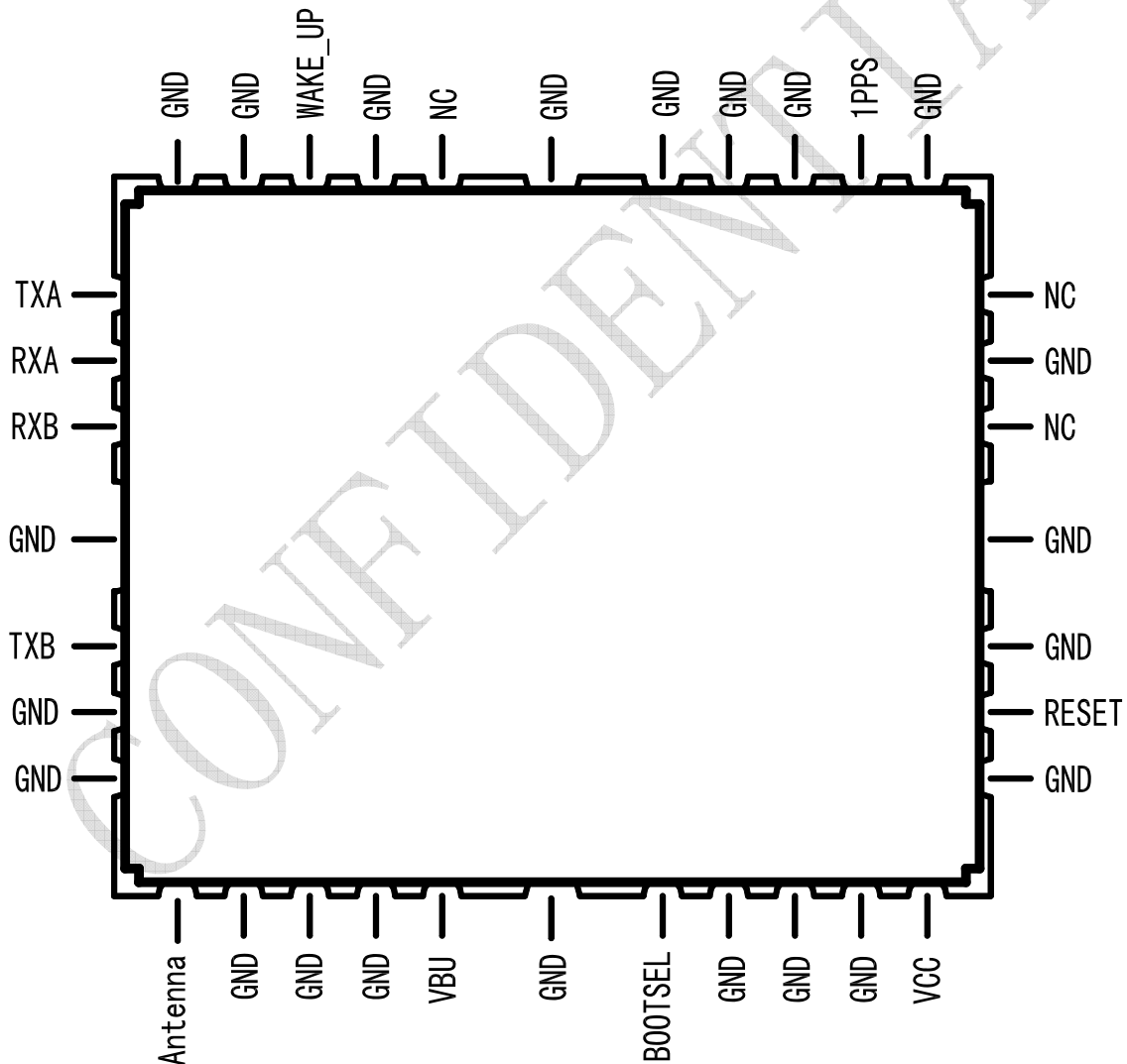

Figure 3

Pin No.	Pin name	Type	Description
1	Antenna	I	Active antenna signal input.1575.42MHZ, 50ohm

2	GND	G	GND
3	GND	G	GND
4	GND	G	GND
5	VBU	I	Backup power input . the type voltage is 3.0V
6	GND	G	GND
7	BOOTSEL	I	user has to keep NC for normal connection
8	GND	G	GND
9	GND	G	GND
10	GND	G	GND
11	VCC	I	The main power input.the type voltage is3.3V
12	GND	G	GND
13	RESET	I	Module reset ,active low Note: user has to keep NC for normal connection
14	GND	G	GND
15	GND	G	GND
16	NC		Reserve for AGPS
17	GND	G	GND
18	NC		user has to keep NC for normal connection
19	GND	G	GND
20	1PPS	O	1 Pulse Per Second
21	GND	G	GND
22	GND	G	GND
23	GND	G	GND
24	GND	G	GND
25	NC		Reserve for AGPS
26	GND	G	GND
27	WAKE_UP	I	user has to keep NC for normal connection
28	GND	G	GND
29	GND	G	GND
30	TXA	O	Serial output for UART A UART A is as NMEA output and JRC command input
31	RXA	I	Serial input for UART A UART A is as NMEA output and JRC command input
32	RXB	I	Serial input for UART B. only for debugging
33	GND	G	GND
34	TXB	O	Serial output for UART B. only for debugging
35	GND	G	GND
36	GND	G	GND

6 Reference PCB layout

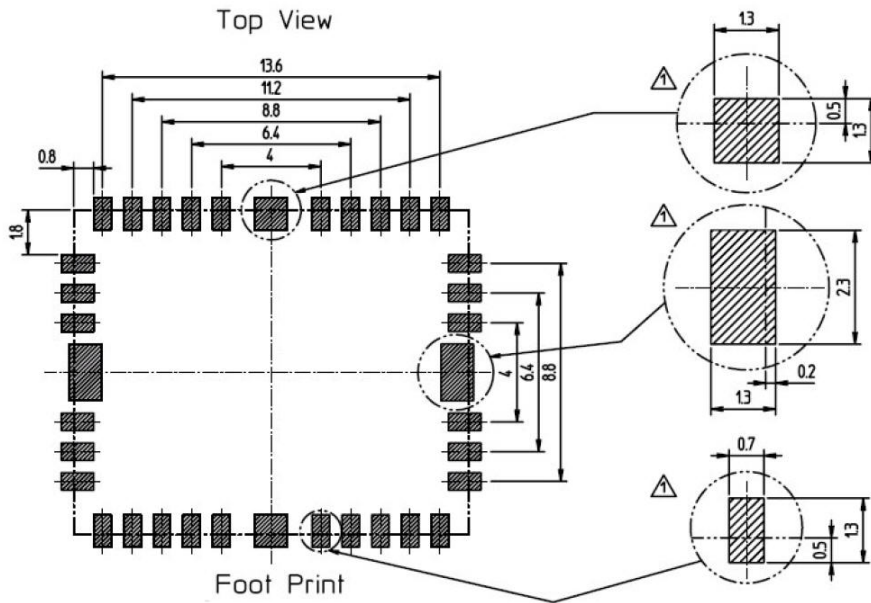

Figure 4



Under the G591 GPS Module should be a ground with green solder mask on the PCB, otherwise will affect the function of the module.

7 Reference Design

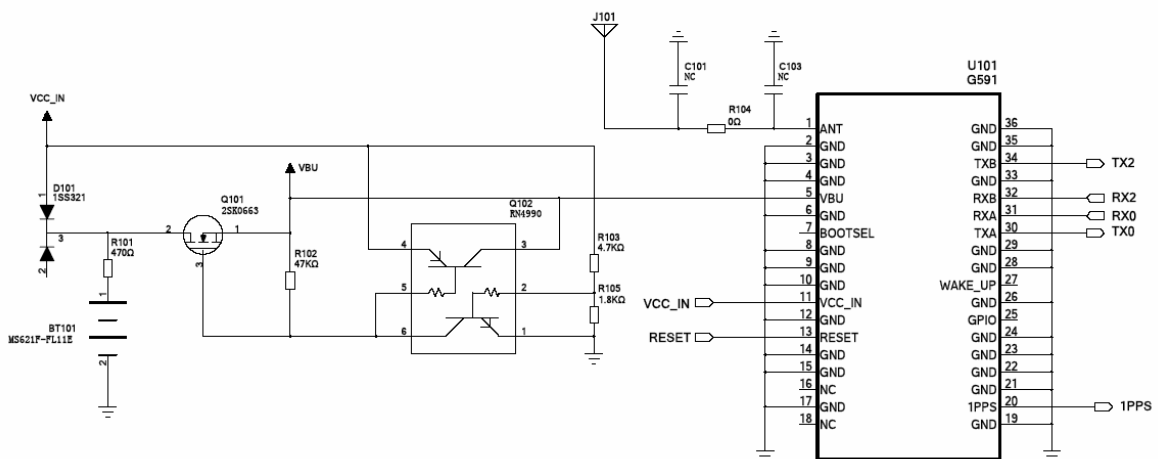

Figure 5

The Figure 5 is the reference design for our customer. We have designed the RF

and Backup power circuit only for reference .Each power input should have EMI capacitor. We recommended the value is 2.2uF or 4.7uF.



In order to obtain the bestest GPS performance, please check:

- Use matching antenna with the module.
- Use the properly test method .

If you have any problems, please contact with our FAE as soon as possible

为了确保 GPS 模块的性能，请使用与模块匹配的天线，请确认测试方式是否合理，如果还有其他的问题，请及时跟我们的 FAE 联系。

7.1 Reference BOM

Description	Package	Man.	Manufacturer P/N	Qty.	Loc.
Chip Resistor, 0Ω,±5%,1/16W	402	Yageo	RC0402JR-07-0RL	1	R104
Chip Resistor, 470Ω,±5%,1/16W	402	Yageo	RC0402JR-07-470R L	1	R105
Chip Resistor, 1.8KΩ,±5%,1/16W	402	Yageo	RC0402JR-07-1K8L	1	R101
Chip Resistor, 4.7KΩ,±5%,1/16W	402	Yageo	RC0402JR-07-4K7L	1	R103
Chip Resistor, 47KΩ,±5%,1/16W	402	Yageo	RC0402JR-07-47KL	1	R102
Silicon epitaxial planar type diode	SOT-23M OD	TOUSIBA	1SS321	1	D101
MS Lithium rechargeable battery		SII	MS621F-FL11E	1	BT101
Silicon N-Channel Junction FET		TOUSIBA	2SK880_E	1	Q101
Silicon epitaxial planar type transistor		TOUSIBA	RN4990	1	Q102
GPS module		JRC	G591	1	U101

8 NMEA output Sentence

The table 2 lists the each of the NMEA output sentence specifically developed and defined by JRC for users within JRC GPS module.

Option	Description
GGA	Global Position System Fix Data. Time. Position and fix related data for a GPS receiver
GSA	GNSS DOP and Active Satellites
GSV	GNSS Satellites in view
RMC	Recommended Minimum Navigation Information
VTG	Course and speed information relative to the ground

Table 2

8.1 .GGA

The GGA contains following information example below:

\$GPGGA,161229.487,3723.2475,N,12158.3416,W,1,07,1.0,9.0,M,17.806,M, ,*18

Name	Example	Unit	Description
Message ID	\$GPGGA		GGA protocol header
UTC Time	161229.487		hhmmss.sss
Latitude	3723.2475		ddmm.mmmmmm
N/S Indicator	N		N=north or S=south
Longitude	12158.3416		dddmm.mmmmmm
E/W Indicator	W		E=east or W=west
Position Fix Indicator	1		0:Fixnotavailable 1:GPSfix 2: Differential GPS fix
Satellites Used	7		Range 0 to 12
HDOP	1		Horizontal Dilution of Precision
MSL Altitude	9	meters	Antenna Altitude above/ below mean -sae-level
Units	M	meters	Units of antenna altitude
Geoidal Separation	17.806	meters	
Units	M	meters	Units of geoidal separation
Age of Diff. Corr.			Null fields when DGPS is not used
Checksum	*18	second	

<CR> <LF>		End of message termination
-----------	--	----------------------------

8.2.GSA

The GSA contains following information example below:

\$GPGSA,A,3,29,21,26,15,18,09,06,10,,,,,2.32,0.95,2.11*00

Name	Example	Unit	Description
Message ID	\$GPGSA		GSA protocol header
Mode 1	A		M: Manual—forced to operate in 2D or 3D mode A: 2D Automatic—allowed to Automatically switch 2D/3D
Mode 2	3		1: Fix not available. 2:2D 3:3D
Satellite Used	29		SV on Channel 1
Satellite Used	21		SV on Channel 2
-----	-----	-----	-----
Satellite Used			SV on Channel 12
PDOP	2.32		Position Dilution of Precision
HDOP	0.95		Horizontal Dilution of Precision
VDOP	2.11		Vertical Dilution of Precision
Checksum	*00		
<CR> <LF>			End of message termination

8.3.GSV

The GSV contains following information example below:

\$GPGSV,3,1,09,29,36,029,42,21,46,314,43,26,44,020,43,15,21,321,39,*7D

\$GPGSV,3,2,09,18,26,314,40,09,57,170,44,06,20,229,37,10,26,084,37,*77

Name	Example	Unit	Description
Message ID	\$GPGSV		GSV protocol header
Number of Messages	3		Range 1 to 3 (Depending on the number of satellites tracked, multiple messages of GSV data may be required.)
Message Number1	1		Range 1 to 3
Satellites in View	9		
Satellite ID	29		Channel 1 (Range 1 to 32)
Elevation	36	degrees	Channel 1 (Maximum 90)
Azimuth	29	degrees	Channel 1 (True, Range 0 to 359)

SNR (C/No)	42	dBHz	Range 0 to 99
-----	-----	-----	-----
Satellite ID	15		Channel 4 (Range 1 to 32)
Elevation	21	degrees	Channel 4 (Maximum 90)
Azimuth	321	degrees	Channel 4 (True, Range 0 to 359)
SNR (C/No)	39	dBHz	Range 0 to 99,(null when not tracking)
Checksum	*7D		
<CR> <LF>			End of message termination

8.4.RMC

The RMC contains following information example below:

\$GPRMC,064951.000,A,2307.125647,N,12016.443856,E,0.036,165.48,260406, ,A,*
65

Name	Example	Unit	Description
Message ID	\$GPRMC		RMC protocol header
UTC Time	64951		hhmmss.sss
Status	A		A=data valid or V=data not valid
Latitude	2307.1256		ddmm.mmmmmm
N/S Indicator	N		N=north or S=south
Longitude	12016.444		dddmm.mmmmmm
E/W Indicator	E		E=east or W=west
Speed Over Ground	0.036	knots	
Course Over Ground	165.48	degrees	TRUE
Date	260406		ddmmyy
Magnetic Variation		degrees	E=east or W=west
Mode	A		A= Autonomous mode D= Differential mode E= Estimated mode
Checksum	*65		
<CR> <LF>			End of message termination

8.5.VTG

The VTG contains following information example below:

\$GPVTG,165.48,T, ,M,0.036,N,0.067,K,A,*37

Name	Example	Unit	Description
Message ID	\$GPVTG		VTG protocol header

Course	165.48	degrees	Measured heading
Reference	T		TRUE
Course		degrees	Measured heading
Reference	M		Magnetic
Speed	0.036	knots	Measured horizontal speed
Units	N		Knots
Speed	0.067	km/hr	Measured horizontal speed
Units	k		Kilometers per hour
Mode			A= Autonomous mode D= Differential mode E= Estimated mode
Checksum	*06		
<CR> <LF>			End of message termination

9 Supplier's Responsibility

9.1 Life Expectancy

The G591 has MTBF>100000 hrs with at least 90% confidence. A prediction of life expectancy will be made by JRC. The result will be discussed with customers.

9.2 Reliability

Design FMEA of the G591 at the part level will be made and documented by JRC. Design FMEA will include the function of the component, failure mode, failure cause, frequency of failure occurrence, and severity of failure.

To detect critical process risks, process FMEA will be made and documented by JRC. Process FMEA will include the function of the component, process stage, failure mode, failure cause, frequency of failure occurrence, severity of failure, and the ability of failure detection.

10 Notice for handling

10.1 Maximum Rating

Do not use over maximum rating because if use over maximum rating it is doubt become the fault.

Maximum voltage

It is regulated maximum voltage which compensate input voltage between input terminal and GND.

Once over the maximum voltage is inputted, it is become the reason of faulty.

Input Voltage

It is regulated maximum voltage to input terminal. Once over the maximum voltage is inputted, it is become the reason of faulty.

Operating Temperature

It is the temperature rang which can have a guarantee for operating corestly. Once over the temperature rang it is become the reason of faulty or it is doubt that can not have the satisfy of the function of GPS.

Storage Temperature

It is the temperature range which unit is strong in case storage temperature is over this temperature rang, it is become the reason of faulty or it can not have a satisfy of the function.

10.2 Caution for Installation

In case handle with this unit, be careful against a static electricity. It is not that unit will be damaged by a static electricity. Specially, handle with I/O connector, be careful against a static electricity. Do not touch the I/O connector dirty with hand.

Please mount within two weeks after opening the prevention-of-moisture packing. After the prevention-of-moisture packing is opened, it need be kept in dry atmosphere.

10.3 Notice for Storage

Do not storage the place where corrosion gas will be generated or exist many dusts. Do not storage the place where temperature rang will be change widely because the dewdrop will be formed therefore.

10.4 Transportation

Do not throw, do not drop, otherwise unit itself will be damaged.

Protect from water, when transport in the rain/snow, protect from them.





10.5 Overcurrent Protection

The G591 does not have a fuse for overcurrent protection.

Please put a fuse for overcurrent protection in your system because the prevention of danger.

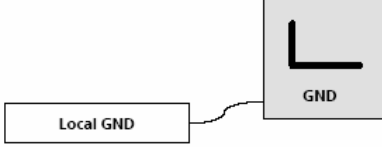
11 ESD handling precautions

GPS receivers are Electrostatic Sensitive Devices and require special precautions when handling. The following items should be paid more attention

	<p>When there is a galvanic coupling with the module, do not ignore the module GND connection to the local GND.</p>
	<p>The RF pin of the module is sensitive to ESD. When handling the module, be careful of the ESD.</p>
	<p>To prevent electrostatic discharge through the RF input, do not touch the mounted patch antenna.</p>
	<p>When soldering RF connectors and patch antennas to the receiver's RF pin, make sure to use an ESD safe soldering iron.</p>



Failure to observe these precautions can result in severe damage to the GPS receiver!

Appendix A Recommended Reflow Temperature Profile(Pb Free)

This are three phases to be recommended: Preheat phase, Heating phase and Cooling phase.

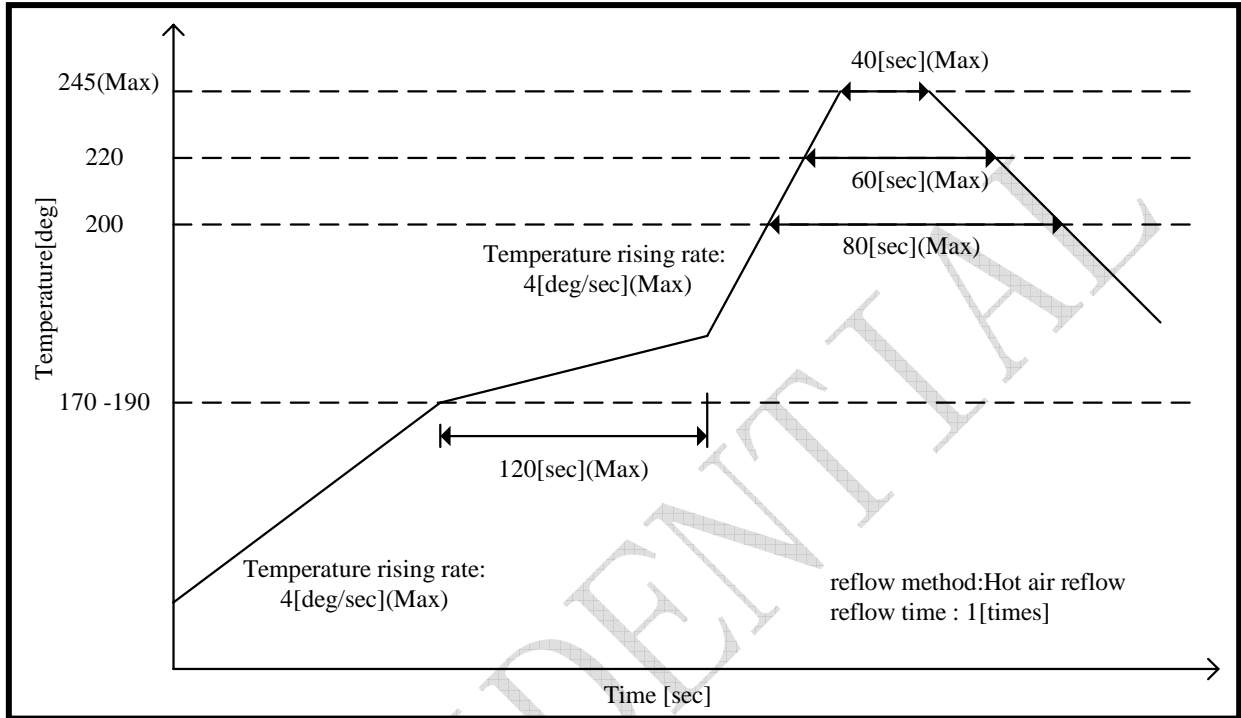

Preheat phase

Item		Notice
Temperature rise rate	1-4 °C/s	If the temperature rise is too rapid in the preheat phase it may cause excessive slumping.
Time	60-120 second	If the preheat is insufficient, rather large solder balls tend to be generated. Conversely, if performed excessively, fine balls and large balls will be generated in clusters.
End temperature	150-200°C	If the temperature is too low, on-melting tends to be caused in areas containing large heat capacity.

Heating phase

Two points need to be noticed:

- Limit time above 220°C liquidus temperature : 20 - 40s
- Peak reflow temperature: 230 - 245°C

Cooling phase

Temperature fall rate	6°C / s (max)
-----------------------	---------------



To avoid falling off during SMT, We request that the G591 module should be place on the topside of the mainboard . (为避免二次过炉对模块造成损坏, 我们要求客户在SMT时, 后贴包含模块的面。)

Appendix B Package Specifications

Appendix B-1. Reel packing method

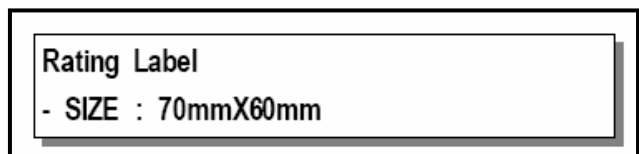
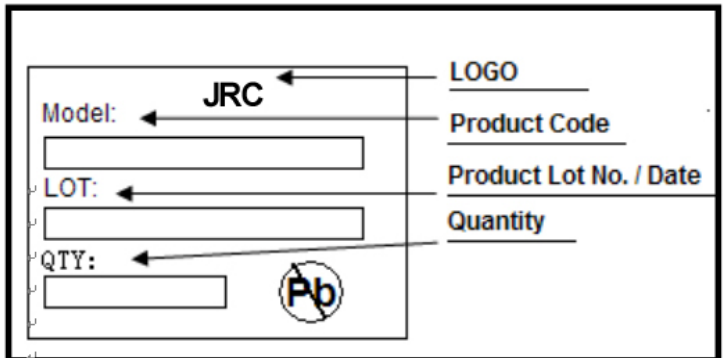
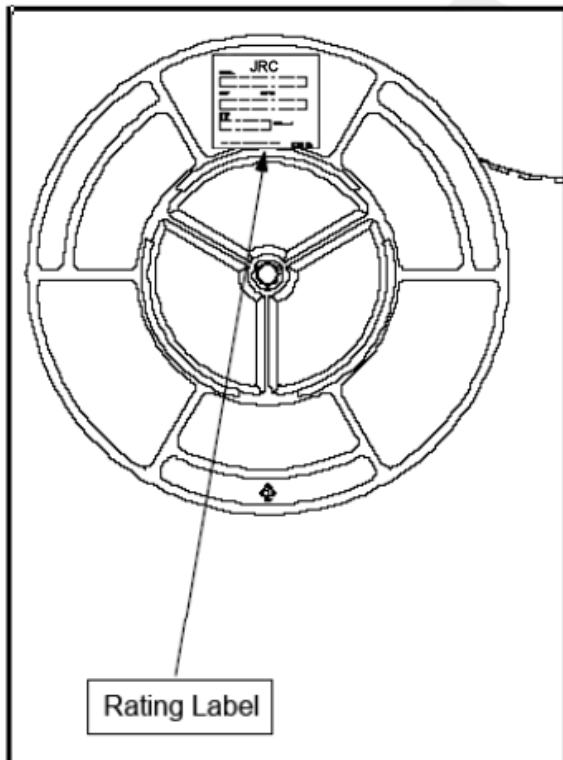

Appendix B-2. The gist of a MSD/LSD label

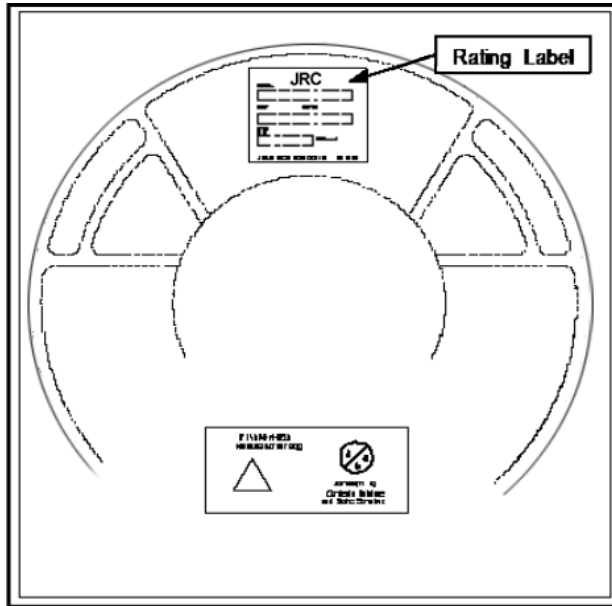

	LEVEL	Notice Mark	Attached
ESD	Class 1C		Yes
MSL	3		Yes

※ For Further Reference : EIA-481-C /

 Reel and tray package can be selected

CONFIDENTIAL